

MDE Semiconductor, Inc.

78-150 Calle Tampico, Unit 210, La Quinta, CA., USA 92253 Tel : 760-564-8656 • Fax : 760-564-2414
1-800-831-4881 Email: sales@mdesemiconductor.com Web: www.mdesemiconductor.com

5.0 SMDJ SERIES

SURFACE MOUNT TRANSIENT VOLTAGE SUPPRESSOR VOLTAGE-12 TO 170 Volts 5000 Watt Peak Pulse Power

FEATURES

- For surface mounted applications in order to optimize board space
- Halogen-Free
- Typical maximum temperature coefficient
 $\Delta VBR=0.1\% \times VBR @ 25^{\circ}C \times \Delta T$
- Low profile package
- Built-in strain relief
- Glass passivated junction
- Low inductance
- Excellent clamping capability
- Repetition rate (duty cycle):0.01%
- Fast response time: typically less than 1.0 ps from 0 volts to BV for unidirectional types
- Typical IR less than 2 μ A above 12V
- High temperature soldering:
260°C/40 seconds at terminals
- Plastic package has Underwriters Laboratory Flammability Classification 94 V-O
- Matte Tin Lead-free plated

DO-214AB (SMC J-Bend)

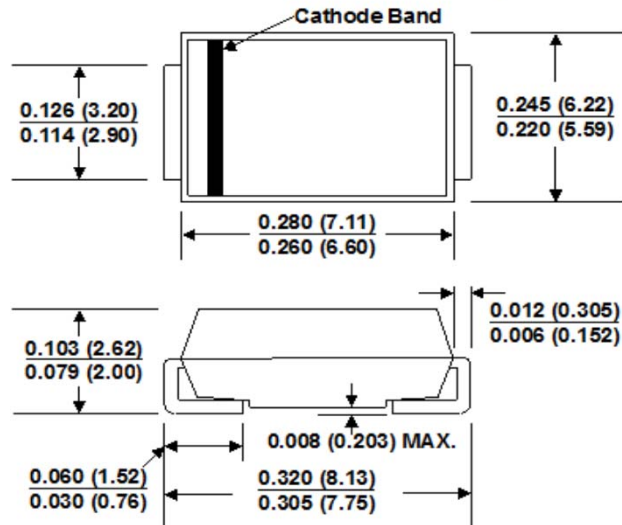

Dimensions in inches and (millimeters)

MECHANICAL DATA

Case: JEDEC DO214AB. Molded plastic over glass passivated junction
 Terminals: Solder plated, solderable per MIL-STD-750, Method 2026
 Polarity: Color band denoted positive end (cathode) except Bidirectional
 Standard Packaging: 16mm tape (EIA STD RS-481)
 Weight: 0.007 ounces, 0.021 grams

MAXIMUM RATINGS AND CHARACTERISTICS

Ratings at 25°C ambient temperature unless otherwise specified.

RATING	SYMBOL	VALUE	UNITS
Peak Pulse Power Dissipation on 10/1000 μ s waveform (NOTE 1, 2, Fig.1)	P_{PPM}	Minimum 5000	Watts
Peak Pulse Current of on 10/1000 μ s waveform (Note 1, Fig 3)	I_{PPM}	SEE TABLE 1	Amps
Peak Forward Surge Current, 8.3ms Single Half Sine-wave Superimposed on Rated Load, (JEDEC Method)(Note2, 3)	I_{FSM}	300	Amps
Operating Junction and Storage Temperature Range	T_J, T_{STG}	-55 +150	°C

NOTES:

1. Non-repetitive current pulse, per Fig.3 and derated above $T_A=25^{\circ}C$ per Fig.2.
2. Mounted on 8.0x8.0mm Copper Pads to each terminal.
3. 8.3ms single half sine-wave, or equivalent square wave, Duty cycle=4 pulses per minute maximum.

MDE Semiconductor, Inc.

78-150 Calle Tampico, Unit 210, La Quinta, CA., USA 92253 Tel : 760-564-8656 • Fax : 760-564-2414
1-800-831-4881 Email: sales@mdesemiconductor.com Web: www.mdesemiconductor.com

5000 Watt Surface Mount TVS

UNI-POLAR	BI-POLAR	DEVICE MARKING CODE		REVERSE STANDOFF VOLTAGE VRWM (V)	BREAKDOWN VOLTAGE VBR (V) MIN. @ IT	BREAKDOWN VOLTAGE VBR (V) MAX. @ IT	TEST CURRENT (I _T) mA	MAXIMUM CLAMPING VOLTAGE @IPP VC (V)	PEAK PULSE CURRENT IPP (A)	REVERSE LEAKAGE @ VRWM IR (µA)
		UNI	BI							
5.0SMDJ12A	5.0SMDJ12CA	5PEP	5BEP	12.00	13.30	14.70	1	19.9	252.0	2
5.0SMDJ13A	5.0SMDJ13CA	5PEQ	5BEQ	13.00	14.40	15.90	1	21.5	233.0	2
5.0SMDJ14A	5.0SMDJ14CA	5PER	5BER	14.00	15.60	17.20	1	23.2	216.0	2
5.0SMDJ15A	5.0SMDJ15CA	5PES	5BES	15.00	16.70	18.50	1	24.4	205.0	2
5.0SMDJ16A	5.0SMDJ16CA	5PET	5BET	16.00	17.80	19.70	1	26.0	193.0	2
5.0SMDJ17A	5.0SMDJ17CA	5PEU	5BEU	17.00	18.90	20.90	1	27.6	181.0	2
5.0SMDJ18A	5.0SMDJ18CA	5PFV	5BFV	18.00	20.00	22.10	1	29.2	172.0	2
5.0SMDJ20A	5.0SMDJ20CA	5PEW	5BEW	20.00	22.20	24.50	1	32.4	155.0	2
5.0SMDJ22A	5.0SMDJ22CA	5PEX	5BEX	22.00	24.40	26.90	1	35.5	141.0	2
5.0SMDJ24A	5.0SMDJ24CA	5PEZ	5BEZ	24.00	26.70	29.50	1	38.9	129.0	2
5.0SMDJ26A	5.0SMDJ26CA	5PFE	5BFE	26.00	28.90	31.90	1	42.1	119.0	2
5.0SMDJ28A	5.0SMDJ28CA	5PFG	5BFG	28.00	31.10	34.40	1	45.4	110.0	2
5.0SMDJ30A	5.0SMDJ30CA	5PFK	5BFK	30.00	33.30	36.80	1	48.4	103.0	2
5.0SMDJ33A	5.0SMDJ33CA	5PFM	5BFM	33.00	36.70	40.60	1	53.3	93.9	2
5.0SMDJ36A	5.0SMDJ36CA	5PFP	5BFP	36.00	40.00	44.20	1	58.1	86.1	2
5.0SMDJ40A	5.0SMDJ40CA	5PFR	5BFR	40.00	44.40	49.10	1	64.5	77.6	2
5.0SMDJ43A	5.0SMDJ43CA	5PFT	5BFT	43.00	47.80	52.80	1	69.4	72.1	2
5.0SMDJ45A	5.0SMDJ45CA	5PFV	5BFV	45.00	50.00	55.30	1	72.7	68.8	2
5.0SMDJ48A		5PFX		48.00	53.30	58.90	1	77.4	64.7	2
5.0SMDJ51A		5PFZ		51.00	56.70	62.70	1	82.4	60.7	2
5.0SMDJ54A		5PGE		54.00	60.00	66.30	1	87.1	57.5	2
5.0SMDJ58A		5PGG		58.00	64.40	71.20	1	93.6	53.5	2
5.0SMDJ60A		5PGK		60.00	66.70	73.70	1	96.8	51.7	2
5.0SMDJ64A		5PGM		64.00	71.10	78.60	1	103.0	48.6	2
5.0SMDJ70A		5PGP		70.00	77.80	86.00	1	113.0	44.3	2
5.0SMDJ75A		5PGR		75.00	83.30	92.10	1	121.0	41.4	2
5.0SMDJ78A		5PGT		78.00	86.70	95.80	1	126.0	39.7	2
5.0SMDJ85A		5PGV		85.00	94.40	104.00	1	137.0	36.5	2
5.0SMDJ90A		5PGX		90.00	100.00	111.00	1	146.0	34.3	2
5.0SMDJ100A		5PGZ		100.00	111.00	123.00	1	162.0	30.9	2
5.0SMDJ110A		5PHE		110.00	122.00	135.00	1	177.0	28.3	2
5.0SMDJ120A		5PHG		120.00	133.00	147.00	1	193.0	26.0	2
5.0SMDJ130A		5PHK		130.00	144.00	159.00	1	209.0	24.0	2
5.0SMDJ150A		5PHM		150.00	167.00	185.00	1	243.0	20.6	2
5.0SMDJ160A		5PHP		160.00	178.00	197.00	1	259.0	19.3	2
5.0SMDJ170A		5PHR		170.00	189.00	209.00	1	275.0	18.2	2

For bidirectional type having Vrwm of 20 volts and less, the IR limit is double.

For parts without A , the VBR is ± 10%

Certified RoHS Compliant

UL File # E223026

MDE Semiconductor, Inc.

78-150 Calle Tampico, Unit 210, La Quinta, CA., USA 92253 Tel : 760-564-8656 • Fax : 760-564-2414
 1-800-831-4881 Email: sales@mdesemiconductor.com Web: www.mdesemiconductor.com

RATING AND CHARACTERISTIC CURVES 5.0SMDJ SERIES

Fig. 1 - Peak Pulse Power Rating Curve

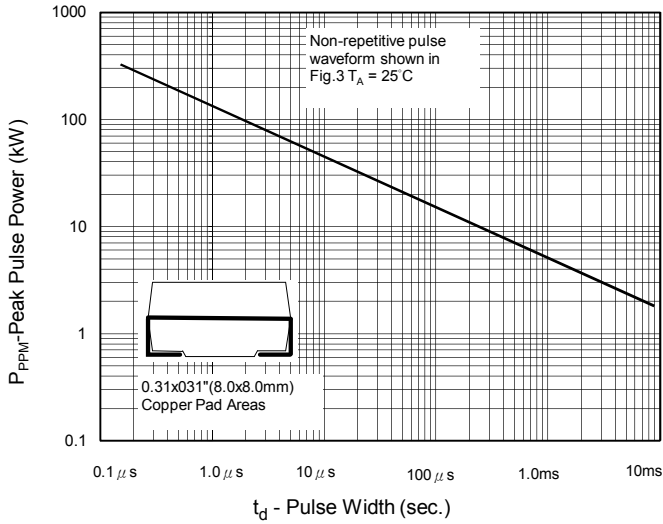

Fig.2 - Pulse Derating Curve

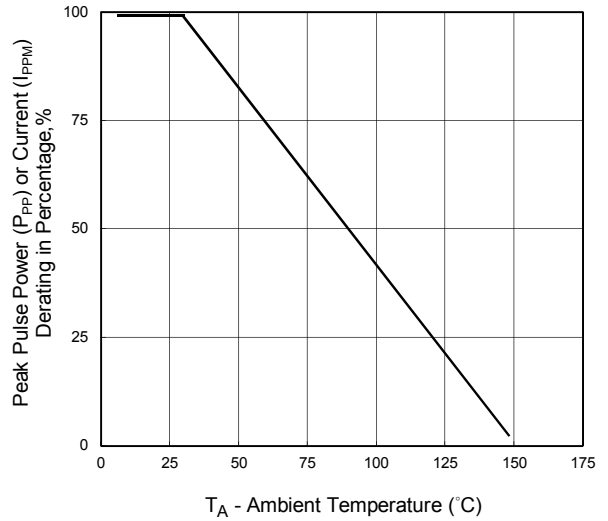

Fig.3 - Pulse Waveform

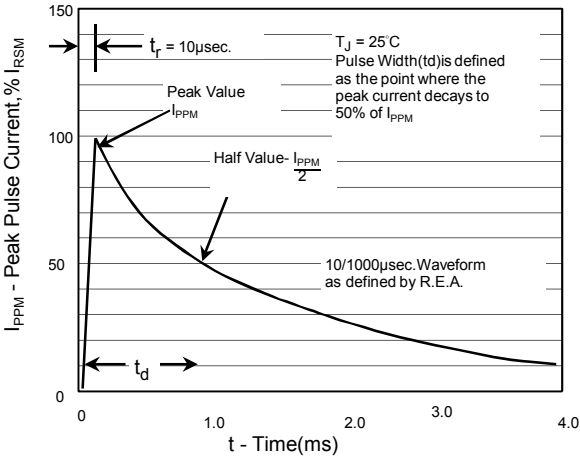

Fig. 4 - Typical Junction Capacitance

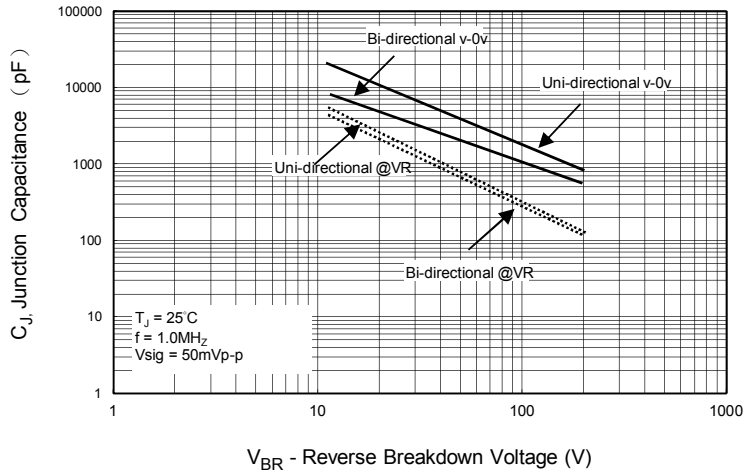

Fig. 5 - Steady State Power Derating Curve

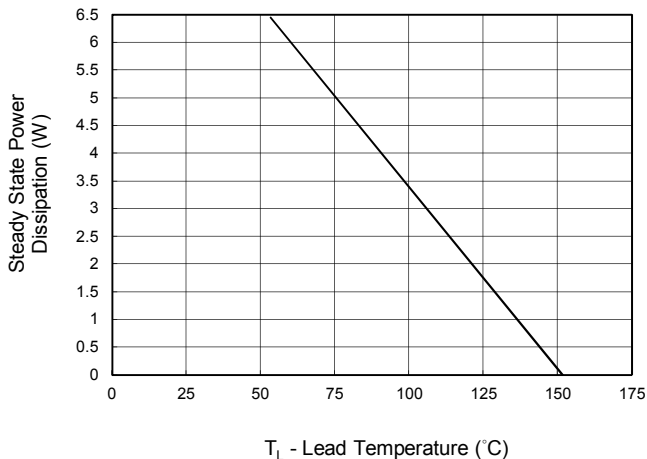
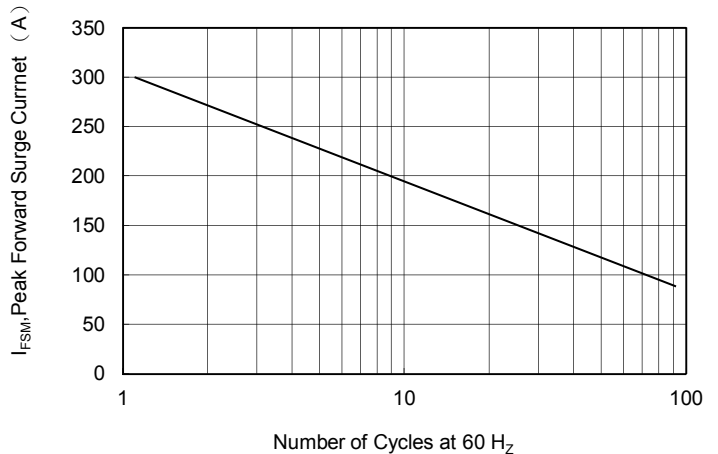

Fig.6 - Maximum Non-repetitive Forward Surge current uni-directional only



MDE Semiconductor, Inc.

78-150 Calle Tampico, Unit 210, La Quinta, CA., USA 92253 Tel : 760-564-8656 • Fax : 760-564-2414
1-800-831-4881 Email: sales@mdesemiconductor.com Web: www.mdesemiconductor.com

5.0 SMDJ SERIES

SURFACE MOUNT TRANSIENT VOLTAGE SUPPRESSOR
VOLTAGE-12.0 TO 15.0 Volts
5000 Watt Peak Pulse Power

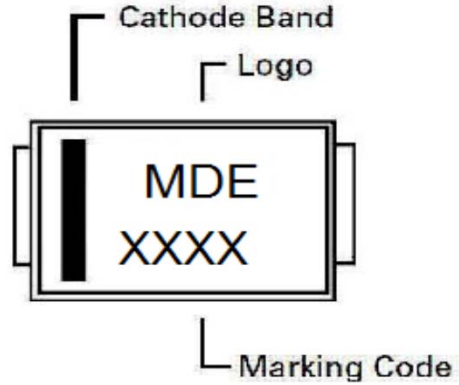
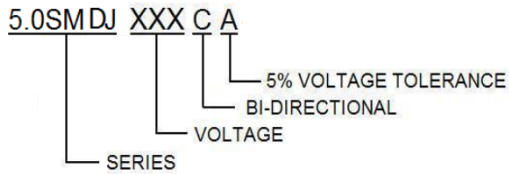

Part number	Component Package	Quantity	Packaging Option	Packaging Specification
5.0SMDJxxxXX	DO-214AB	3000	Tape & Reel - 16mm/13" tape	EIA STD RS-481
5.0SMDJxxxXX	DO-214AB	500	Tape & Reel - 16mm/ 7" tape	EIA STD RS-481